

TOP VIEW

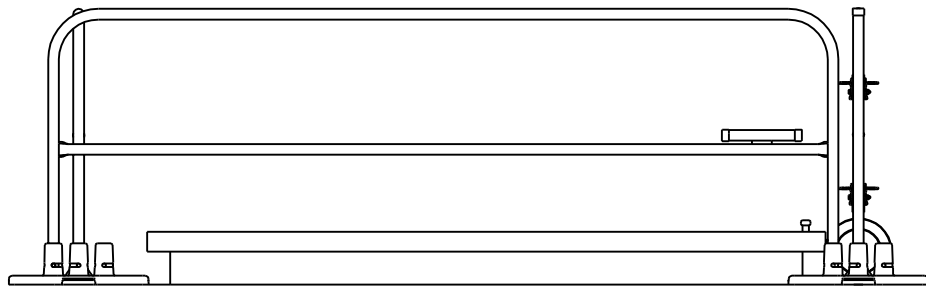

SIDE VIEW

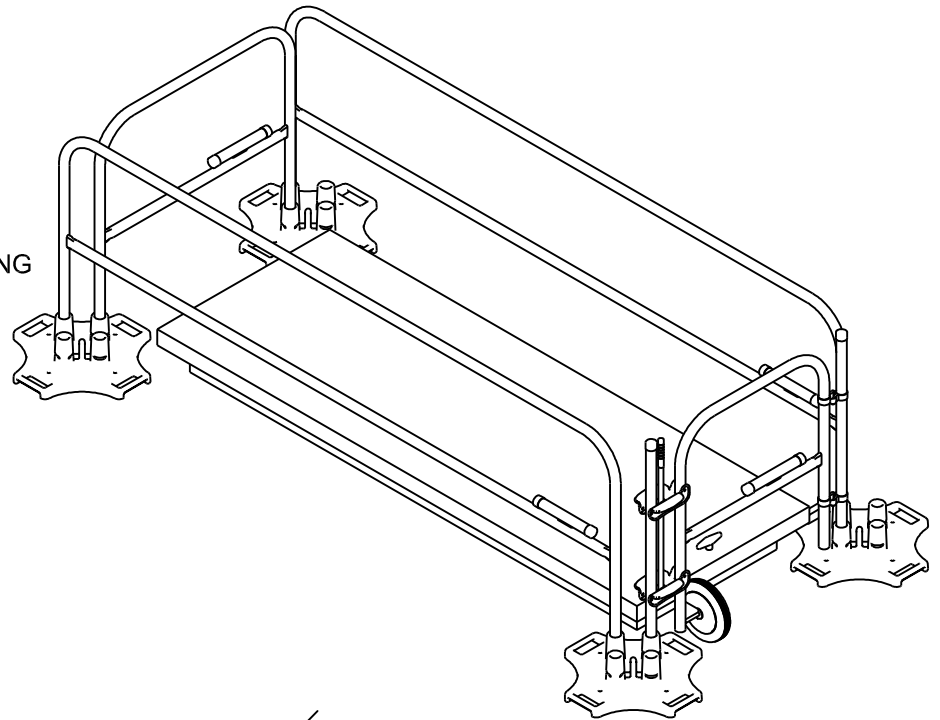
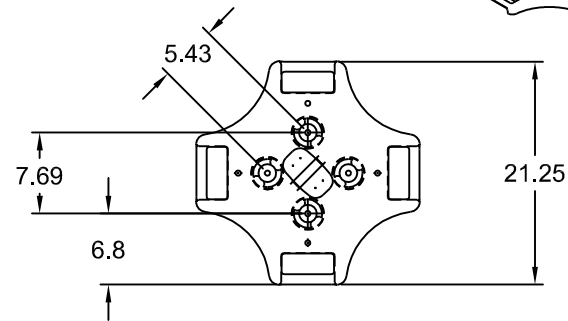

BASE DETAIL

**BlueWater Mfg.**  
 P.O.Box 203  
 7914 Kerber Blvd.  
 Chanhassen, MN 55317

Tel: 952-926-0515  
 Toll Free: 866-898-5237  
 Fax: 952-926-0518  
 info@bluewater-mfg.com  
 www.safetyrail2000.com

## Stairway Hatch Safety Rail Kit

Dwg No.	Rev.	Sheet
500048	B	1/1